

POWER

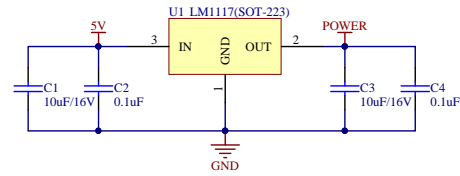

LDO

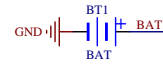

BATTERY

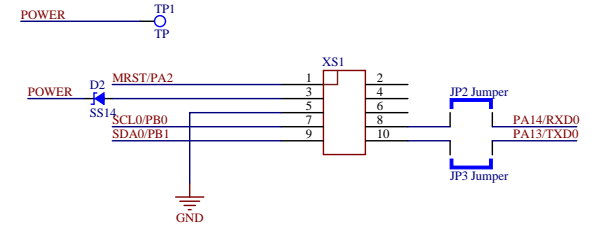

ES-LINK2\_INTERFACE

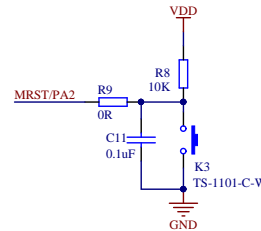
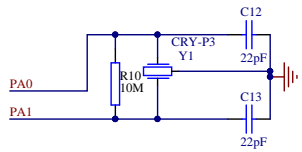

RSET

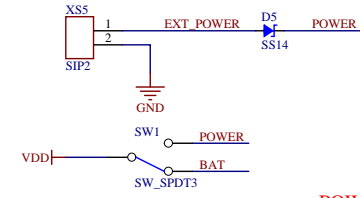

POWER SELECT

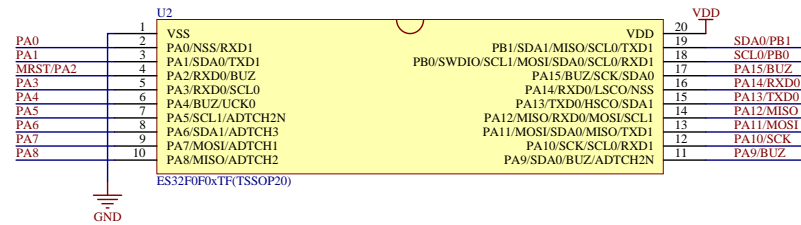

MCU

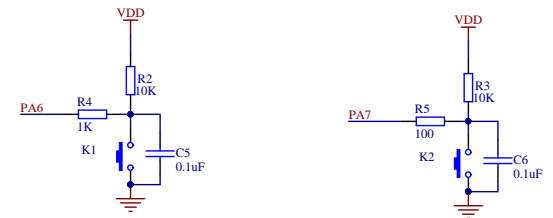

KEY

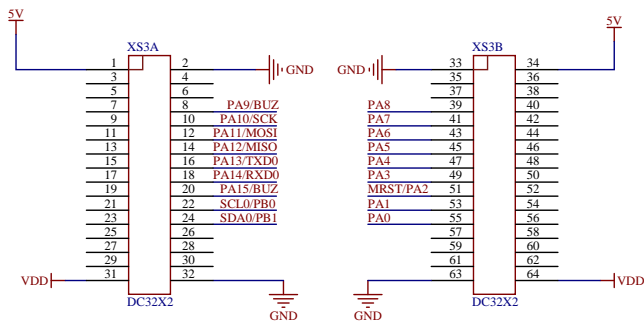

NOMAL\_INTERFACE

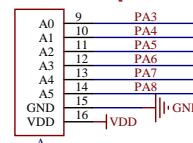
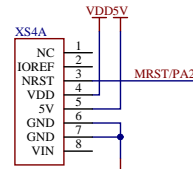

ARDUINO\_INTERFACE

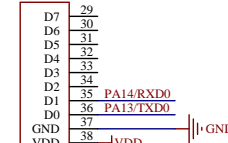
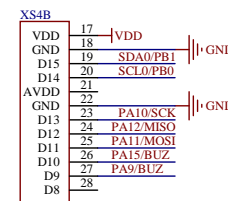

ARDUINO\_INTERFACE

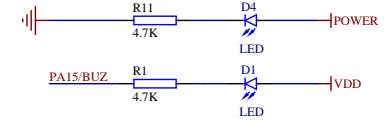

LED

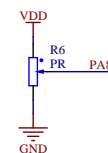

Potentiometer

Title:	ES-PDS-ES32F010xDB1
Project:	ES-PDS-ES32F0100DB1.PrjPcb
Version:	V1.0
Date:	2021/2/25
Size:	A3
Sheet:	1 of 1

